

FEC30W SERIES

DC / DC Single & Dual Output: 30 Watts



Features

- 4:1 wide Input range option 10~40V & 18~75V
- Single & Dual outputs
- Industry Standard 2 x 1.6in package
- High efficiency up to 82%
- Regulated output & Short circuit protection
- 1600V isolation
- Five sided continuous copper shield
- Remote ON / OFF- Standard Positive Logic
- Remote ON / OFF- Negative Logic - Option
- High operating temperature +85°C
- Fixed switching frequency
- Optional heat sink: P/N: 7G-0011C-F

Specifications:

Input Voltage	24VDC (10 ~ 40) 48VDC (18 ~ 75)	Efficiency	Model dependant 80 ~ 88%
Input Filter	L-C type	Isolation	1600VDC
Input Surge Voltage. (100mS)	24V: 50VDC. 48V: 100VDC	Isolation Cap.	1000pF
Input Reflected Ripple Current	20mA pk-pk @ nominal input & 100% load	Switching Freq.	300KHz
Start Up time	10mS constant resistive load	Safety	EN60950-1, UL60950-1
Remote ON/OFF (Positive logic – Standard)	DC-DC ON Open or 3.0V < Vr < 12V DC-DC OFF Short or 0V < Vr < 1.2V	Case Material	Nickel-coated copper
(Negative logic – Option)	DC-DC ON Short or 0V < Vr < 1.2V DC-DC OFF Open or 3.0V < Vr < 12V Input current of remote control pin: .5mA Remote off state input current: 3mA	Base Material	Non-conductive black plastic
Output power	30 watts	Potting	Epoxy UL94-V0
Voltage Accuracy	±1.0%	Dimensions	50.8 x 40.6 x 10.2mm
Minimum Load	Zero load	Weight	48g
Voltage Trim	±10% (Single & Dual)	MTBF	1.315 x 10 ⁶ Hrs
Line Regulation	Single ±0.5% Dual ±0.5%	Operating Temp	-40°C to +85°C (with derating)
Load Regulation	Single ±0.5% , Dual ±1% (Min load -100% load)	Case Temp	+100°C maximum case temperature
Cross Regulation	±5% Asymmetrical load: 25-100% load)	Thermal Impedance	10°C / watt Standard convection 8.24°C / watt with optional heatsink
Ripple & noise	See table. 20MHZ bandwidth	Thermal shock	MIL-STD-810F
Temp. Coefficient	±0.02% / °C	Vibration	10-55Hz, 10G, 30min along X, Y,Z
Transient Response	250uS (25% load step change)	Humidity	5-95% RH
Over Voltage Protection	1.5V ~ 3.3V: 3.9V: 5.0V: 6.2V 12V: 15V 15V: 18V	EMC	EN55022 Class A Consult office for Class B design
Overload Protection	Typically 150% of load	ESD	EN61000-4-2
Short Circuit protection	Continuous hiccup mode	Radiated Immunity	EN61000-4-3
		Fast Transients	EN61000-4-4
		Surge	EN61000-4-5
		Conducted Immunity	EN61000-4-6

FEC30W SERIES

DC / DC Single & Dual Output: 30 Watts



Model	Input V	Output V	Output Current		Output Ripple & Noise	Input Current		Eff (%)	Capacitor Load max
			Min. load	Full load		No load	Full load		
FEC30-24S1P5W	10 – 40 V	1.5 V	0mA	8000mA	60mVp-p	35mA	658mA	80	65000uF
FEC30-24S1P8W	10 – 40 V	1.8 V	0mA	8000mA	60mVp-p	35mA	759mA	83	65000uF
FEC30-24S2P5W	10 – 40 V	2.5 V	0mA	8000mA	60mVp-p	40mA	1029mA	85	33000uF
FEC30-24S3P3W	10 – 40 V	3.3 V	0mA	6000mA	60mVp-p	50mA	994mA	87	19500uF
FEC30-24S05W	10 – 40 V	5 V	0mA	6000mA	75mVp-p	65mA	1506mA	87	10200uF
FEC30-24S12W	10 – 40 V	12 V	0mA	2500mA	100mVp-p	65mA	1506mA	87	3300uF
FEC30-24S15W	10 – 40 V	15 V	0mA	2000mA	100mVp-p	70mA	1488mA	88	1100uF
FEC30-24D12W	10 – 40 V	±12V	0mA	±1250mA	100mVp-p	30mA	1563mA	84	±1000uF
FEC30-24D15W	10 – 40 V	±15V	0mA	±1000mA	100mVp-p	35mA	1543mA	85	±680uF
FEC30-48S1P5W	18 – 75 V	1.5 V	0mA	8000mA	60mVp-p	20mA	329mA	80	65000uF
FEC30-48S1P8W	18 – 75 V	1.8 V	0mA	8000mA	60mVp-p	20mA	380mA	83	65000uF
FEC30-48S2P5W	18 – 75 V	2.5 V	0mA	8000mA	60mVp-p	25mA	508mA	86	33000uF
FEC30-48S3P3W	18 – 75 V	3.3 V	0mA	6000mA	60mVp-p	30mA	497mA	87	19500uF
FEC30-48S05W	18 – 75 V	5 V	0mA	6000mA	75mVp-p	30mA	744mA	88	10200uF
FEC30-48S12W	18 – 75 V	12 V	0mA	2500mA	100mVp-p	35mA	753mA	87	3300uF
FEC30-48S15W	18 – 75 V	15 V	0mA	2000mA	100mVp-p	45mA	744mA	88	1100uF
FEC30-48D12W	18 – 75 V	±12V	0mA	±1250mA	100mVp-p	25mA	772mA	85	±1000uF
FEC30-48D15W	18 – 75 V	±15V	0mA	±1000mA	100mVp-p	25mA	762mA	86	±680uF

Notes:

1. MTBF as per BELLCORE TR-NWT-000332. Case 1: 50% Stress, Temperature at 40°C. (Ground fixed and controlled environment).
2. Typical values at nominal input voltage and full resistive load.
3. Test by minimum Vin and constant resistive load.
4. The ON/OFF control pin voltage is referenced to -Vin.
To order negative logic ON-OFF control add the suffix-N (eg: FEC30-24S05W-N).
5. Heat sink is optional and P/N: 7G-0011C-F
6. The FEC30W series can meet EN55022 Class A with parallel an external capacitor to the input pins.
Recommend: 24Vin : 6.8µF/50V 1812 MLCC , 48Vin : 2.2µF/100V*2 PCS 1812 MLCC.
7. An external filter capacitor is required if the module has to meet EN61000-4-5.
Filter capacitor recommended: Nippon chemi-con KY series, 220µF/100V, ESR 48mΩ.

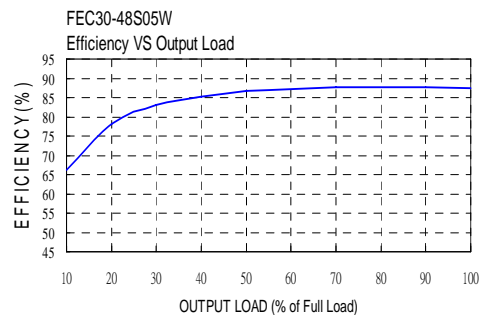
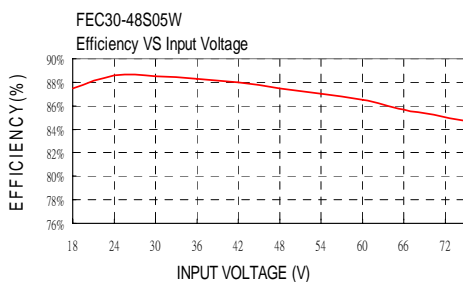
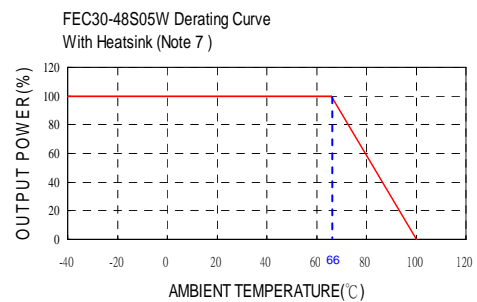
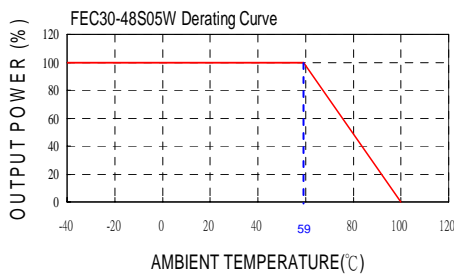

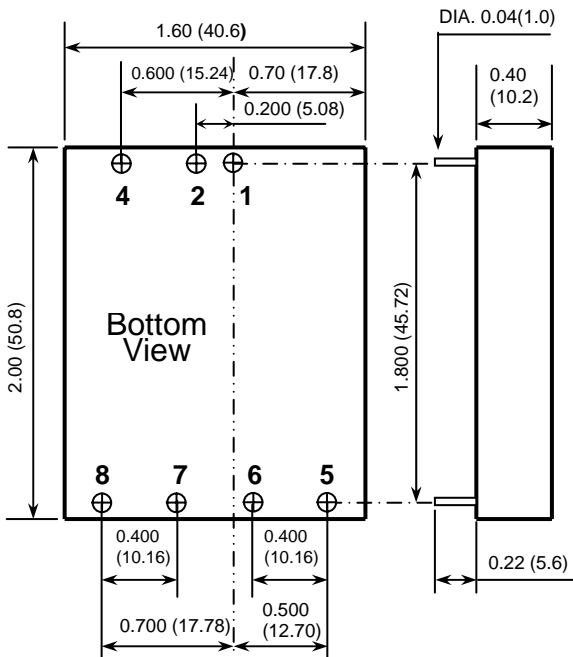

- All dimensions in Inches (mm)
Tolerance: X.XX±0.02 (X.X±0.5)
X.XXX±0.01 (X.XX±0.25)
- Pin pitch tolerance ±0.01(0.25)
- Pin dimension tolerance ±0.004 (0.1)

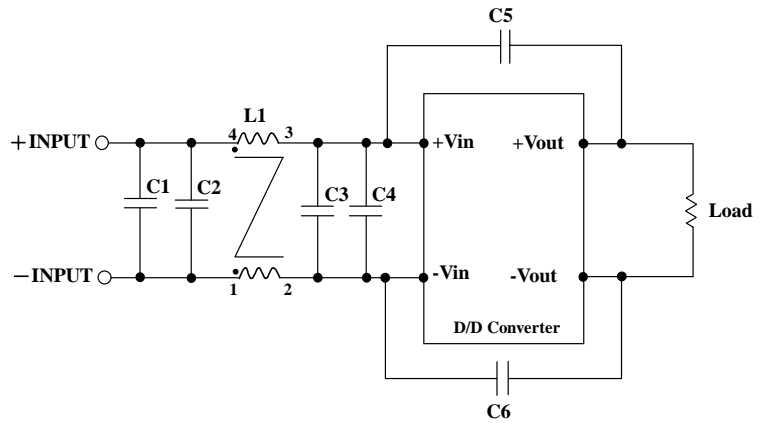

Recommended Filter for EN55022 Class B Compliance

The components used in the above figure, together with the manufacturers' part numbers for these components, are as follows:

	C1	C2	C3	C4	C5 & C6	L1
FEC30-24xxxW	6.8uF/50V 1812 MLCC	N/A	6.8uF/50V 1812 MLCC	N/A	1000pF/2KV MLCC	450uH Common Choke PMT-048
FEC30-48xxxW	2.2uF/100V 1812 MLCC	2.2uF/100V 1812 MLCC	2.2uF/100V 1812 MLCC	2.2uF/100V 1812 MLCC	1000pF/2KV MLCC	450uH Common Choke PMT-048

Pin Assignment		
PIN	SINGLE	DUAL
1	+ INPUT	+ INPUT
2	- INPUT	- INPUT
4	CTRL	CTRL
5	NO PIN	+ OUTPUT
6	+ OUTPUT	COMMON
7	- OUTPUT	- OUTPUT
8	TRIM	TRIM

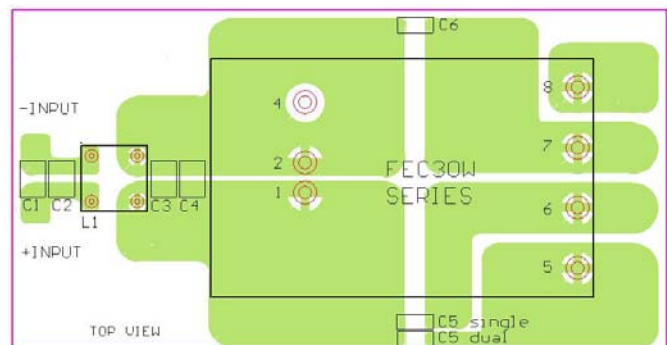
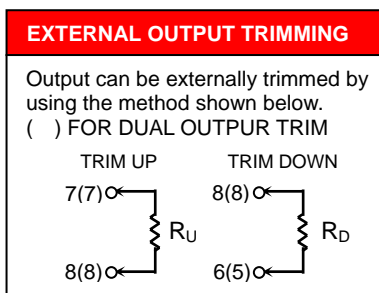

Recommended EN55022 Class B Filter Circuit Layout